

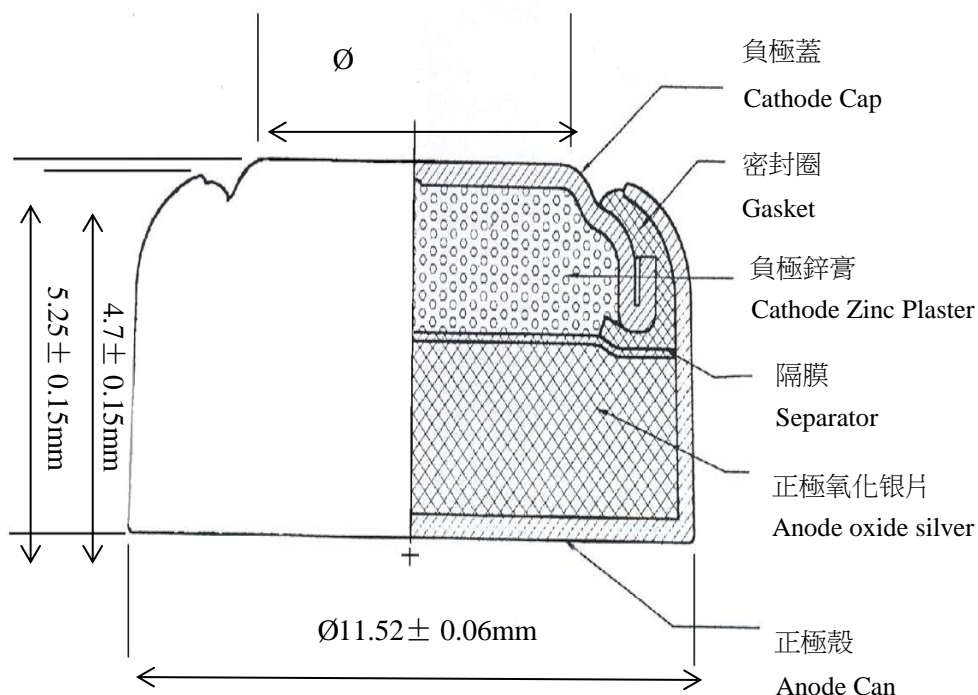

WAMA ELECTRONICS TECHNOLOGY CO.,LTD

SR44SW,357/309,SR1154 BUTTON CELL

DIMENSIONS:



NOMINAL VOLTAGE : 1.55 VOLT

APPROX. SERVICE CAPACITY : 180 mAh

APPROX. WEIGHT : 1.86 g

RATED AT 7.5K Ω LOAD TESTED AT 21°C WITHIN 12 MONTHS OF MANUFACTURE.

SYSTEM : ZINC /MANGANESE DIOXIDE.

ESTIMATED AVERAGE HOURS SERVICE AT 21 °C

